

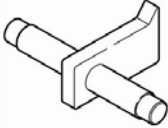

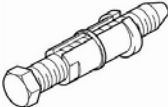

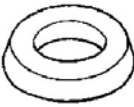

# Volkswagen To

# Engine Crankshaft, Pistons

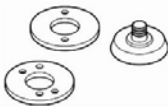
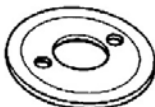
# 13

Tool Number	Application	Models	
10-201	<b>FLYWHEEL LOCK</b> Locks flywheel in place during removal and installation.	Audi - 4000, AAN VW - Fox, Dasher, Quantum	<b>NEW</b> 
10-202	<b>CLUTCH PILOT BEARING PULLER</b> Replaced by W1088.	Audi - 4000, 5000 1984< VW - Vanagon	
10-205	<b>MOUNTING SLEEVE</b> Guides flywheel oil seal over crankshaft during installation. Use with 2003/1.	Audi - 4000 VW - Dasher	
124	<b>CONNECTING ROD CHISEL</b> Use topeen mounting nuts of connecting rods.	Audi - All VW - All	
2003	<b>SEAL INSTALLER KIT</b> Flywheel seal installer kit. Includes protector 2003/2A and driving pads 2003/1 and 2003/3.	Audi - AAH, AFC, AAN VW - All	
2003/1	<b>SEAL DRIVER</b> Flywheel seal installer for models before 1998.	Audi - AAH, AFC, AAN VW - All	
2003/2A	<b>SEAL PROTECTOR</b>	Audi - 100, 200 1991> VW - All	
2003/3	<b>CRANKSHAFT SEAL DRIVER</b> Flywheel seal installer for V6 models from 1992.	Audi - AAH, AFC, AHA, ATQ VW - VR6	
2026	<b>MANDREL</b> Installs crankshaft needle bearing on 5 cylinder engines. See 207C or 222 for 4 cylinder engines.	Audi - All VW - All	

800-848-6657 Toll Free  
941-927-1414 Intl'  
941-927-1612 Fax









www.baumtools.com  
sales@baumtools.com

# Volkswagen To

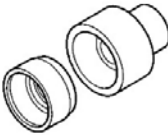
# Engine Crankshaft, Pistons

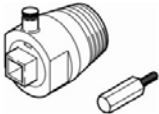
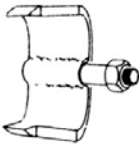
# 13

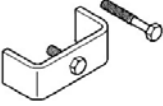
Tool Number	Application	Models	
204B	<b>FLYWHEEL OIL SEAL DRIVER</b> Installs seals in engine and transmission. Removes starter bushings and wheel bearings. Is also used for a variety of other press operations.	VW - TYPE 1, 2, 3, 4, Quantum Audi - 4000	
2058  1	<b>SLEEVE</b> Protects seal of rear cover plate when installed over pinion shaft on transmission (089).	Golf, Jetta 1985>, Dasher, Quantum, Vanagon Audi - 4000	
2079  6	<b>CRANKSHAFT PULLEY NUT WRENCH</b> Removes and installs crankshaft pulley nut on all 5 cylinder engines while in car. Use with 2084, 3197 or 3256 (above).	VW - Fox, Quantum Audi - 4000, 5000, 100, 200, S4, S6, A8, V8	
2080A	<b>DRIVER AND SLEEVE</b> Installation of front crank pulley seal on 5 cylinder engines.	VW - Dasher, Quantum Audi - 4000, 5000, 80, 90, AAN	
2084  12	<b>CRANK PULLEY HOLDER</b> Locks crankshaft pulley to facilitate removal of bolt on 5 cylinder models. Use with 2079 below. See #3256 1992 and later models.	VW - Dasher, Quantum Audi - 4000, 5000, 80, 90, AAN	
2085  5	<b>SEAL PULLER - 32mm</b> Removes balance shaft and camshaft oil seals. Replaces 2002 and 10-219.	Audi - 100, 200 1991>, S4, S6, V6 5000 1984> VW -Golf, Jetta, >1985, Fox, Quantum, Scirocco	
215C	<b>FLYWHEEL LOCK - 12 VOLT</b> Locks flywheel for easy removal of crankshaft gland nut.	Vanagon	
30-100  1	<b>PRESS TUBE</b> Use to install chain sprocket on crankshaft end. Also used for various other press operations.	Audi - AVK	
3034	<b>IDLER PULLEY PULLER</b> To remove camshaft belt idler pulley. Removes tensioning roller pulley from oil pump.	Audi - 4000, 5000 VW - Quantum	

800-848-6657 Toll Free  
941-927-1414 Intl'  
941-927-1612 Fax





www.baumtools.com  
sales@baumtools.com

# Volkswagen To

# Engine Crankshaft, Pistons

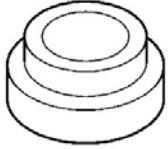
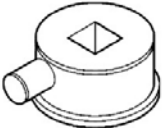
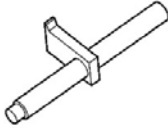
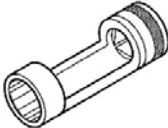
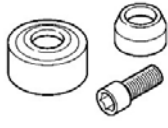
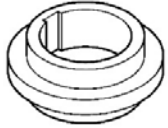
# 13

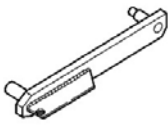
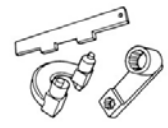
Tool Number	Application	Models	
30-506B	<b>PRESS PAD - CRANKSHAFT NEEDLEBEARING</b> Installs crankshaft needle bearing in flywheel.	AAN	
3052	<b>ADAPTER</b> Use to turn crankshaft with extension and t-handle.	Vanagon.	
3067	<b>FLYWHEEL LOCK</b> Holds flywheel in position when torquing bolts.	Vanagon Diesel.	
3078	<b>CAMSHAFT SOCKET - 22mm</b> Socket for turning camshaft into position during belt replacement and assembly.	Audi - ART, AWN, BBD	
3083  2	<b>OIL SEAL DRIVER</b> Installs crankshaft pulley seal.	Audi - 4000 VW - Rabbit, Jetta, Golf, GTI, Fox, Dasher, Quantum, Scirocco, AEB, ATW	
3088	<b>OIL SEAL DRIVER</b> Installs crankshaft pulley seal.	Vanagon Waterbox	
3099	<b>SPUR BELT LOCK</b> Locks spur belt when removing and installing crankshaft O-ring and during tension adjustment.	Audi - 4000, Audi - 4000 Quattro. VW - All 4 Cyl. 1985> except Vanagon	
3102	<b>PULLEY HOLDER</b> Prevents engine from turning while removing or installing pulley bolt.	Vanagon 1.9 Liter	
3149	<b>PULLEY RETAINER KIT</b> Use to hold three groove v belt pulley during removal and installation.	Vanagon 2.1 Liter	

800-848-6657 Toll Free  
941-927-1414 Intl'  
941-927-1612 Fax







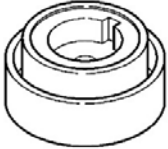

[www.baumtools.com](http://www.baumtools.com)  
[sales@baumtools.com](mailto:sales@baumtools.com)

# Volkswagen To

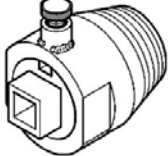
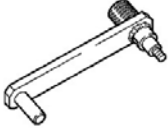
# Engine Crankshaft, Pistons

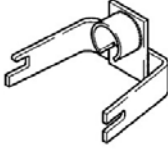
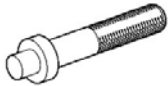
# 13

Tool Number	Application	Models	
3162	<b>OIL SEAL DRIVER</b> Installs pulley end crankshaft seal.	Vanagon Synchro	
3197  23	<b>VIBRATION DAMPER HOLDER</b> Holds vibration damper on V-8 while removing and installing. Use with socket #2079.	VW - V8 Audi - A8 1996-1999 Engines: ABZ & AEW	<b>NEW</b> 
3203  12	<b>SEAL REMOVER - 35mm</b> Removes front crankshaft (pulley) seal at the vibration damper. See seal installer 3202 Pg. (16) and 2003/3 Pg. (17).	VW - VR6 Audi - AAN, AAH, AFC, APB, AVK, V8	
3211  2	<b>VIBRATION DAMPER LOCK</b> Holds crankshaft vibration damper when adjusting timing. Use with 3199, 3204 and 4493.	V8	<b>NEW</b> 
3242  527	<b>CRANKSHAFT LOCK PIN</b> Holds crankshaft at TDC (top dead center) when removing and installing toothed timing belt and flywheel/drive plate. Use with #T10060, #3243 and/or #3391.	AAH, AFC, APB, AHA, ATQ, ART, AWN, BBD	<b>NEW</b> 
3243  194	<b>CAMSHAFT HOLDER - V6 4-VALVE</b> Holds camshaft at TDC during reassembly and timing. Use with #T10060 and #3242. See #3391 for V6 5 valve engines.	AAH, AFC	<b>NEW</b> 
3248A	<b>VIBRATION DAMPER COUNTER HOLDER</b> Locks position of vibration damper and crankshaft sprocket when removing to replace front crankshaft seal on models with poly ribbed v-belts.	Audi - V6, V8 VW - T4 Eurovan	
3264	<b>NEEDLE BEARING DRIFT</b> Needle bearing drift for crankshaft needle bearings and other roller bearings.	Audi - APB, AVK VW - VR6 Engine	
3266	<b>PULLEY SEAL INSTALLER</b> Installs crankshaft pulley oil seal. Use with vibration damper lock #3273.	VR6	

800-848-6657 Toll Free  
941-927-1414 Intl'  
941-927-1612 Fax







www.baumtools.com  
sales@baumtools.com

# Volkswagen To

# Engine Crankshaft, Pistons

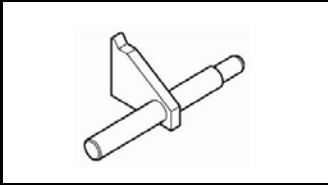
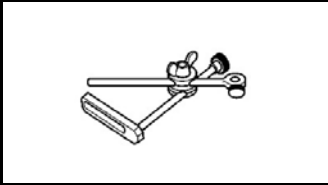
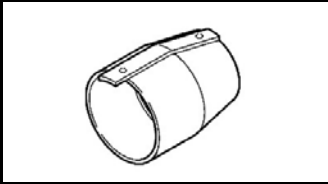
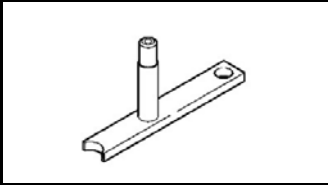
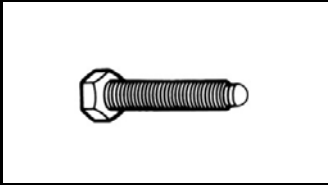
# 13

Tool Number	Application	Models	
3299  11	<b>RIBBED BELT INSTALLER</b> Removes and installs ribbed V-belts on the generator.	Audi - AVK	
3369  21	<b>SUPPORT SLEEVES</b> Use to support front end when removing or installing the lock carrier on the hood.	Audi - A4, AVK	
3386	<b>FLYWHEEL LOCK</b> Locks flywheel in place during removal and installation.	Polo 1995->	
387  11	<b>DIAL INDICATOR STAND - UNIVERSAL</b> Use to hold dial indicator to studs by housing holes to make measurements of flywheel end play, transmission depth, valve play...etc.	Audi - All	
428A	<b>GUIDE TUBE</b> Use to facilitate the installation of the camshaft and timing gear. Replaces 427 and 428.	VW, Audi - All	
558  2	<b>FLYWHEEL LOCK</b> Flywheel and pressure plate locking pin.	Rabbit, GTI, Golf, Jetta, Scirocco	
B2001	<b>DRIVE BELT TENSIONER REMOVER</b> Special bolt for removing drive belt tensioner on VR6 engines.	VR6 Engine	
H2567-1	<b>OIL DRAIN WRENCH - 17mm HEX X 19mm BOX</b> Use to remove gearbox drain and filler plugs with 17mm Allen and oil pan drain plugs with 19mm box wrench.	VW, Audi - All	
W1088  8	<b>PILOT BEARING PULLER - 10mm - 25mm</b> Universal pilot bearing and bushing puller. Particularly narrow format and sharp lip allows access to even the hardest to get at bushings and bearings without damage. Replaces #10-202.	Audi - 4000, 5000 1984-< VW - Vanagon	

800-848-6657 Toll Free  
941-927-1414 Intl'  
941-927-1612 Fax



www.baumtools.com  
sales@baumtools.com

# Volkswagen To

# Engine Crankshaft, Pistons 13

Tool Number	Application	Models	
W1088T  1	<b>PILOT BEARING PULLER REPLACEMENT ARMS (2)</b> Replacement arms for Pilot Bearing Puller #W1088.	VW, Audi - All	
T40001  95	<b>CAMSHAFT SPROCKET PULLER</b> See Kukko #KK118.	Audi - APB, ART, AWN, BBD	<b>NEW</b> 
T40005  78	<b>CAMSHAFT HOLDER - V8</b> Use to lock camshafts relative to each other when replacing belts, tensioners or when removing crank bolts. AUDI A6, 4.2L, V8.	Audi - ART, AWN, BBD	<b>NEW</b> 
T40009  23	<b>PULLEY TIGHTENER</b> Used when tensioning of tooth belt with proper tightening torque on AUDI A6 4.2L, V8	Audi - ART, AWN, BBD	<b>NEW</b> 
T40026  89	<b>LOCKING PIN</b> Use to lock the camshafts for installation of drive belt.	Audi - AVK	<b>NEW</b> 
T40028  69	<b>CAMSHAFT ADJUSTER SOCKET</b> Special groove nut socket to turn the camshaft adjuster into position.	Audi - AVK	<b>NEW</b> 
T40030  76	<b>CAMSHAFT ADJUSTMENT GAUGE SET</b> Use to adjust the left and right camshafts.	Audi - AVK	<b>NEW</b> 
3273	<b>VIBRATION DAMPER LOCK</b> Locks vibration damper when removing and installing mount bolts.	VR6 1992-97 Engine: AAA	
H794U-3	<b>PISTON RING COMPRESSOR 70mm - 110mm RANGE</b> Use to compress piston rings when installing pistons into engine case.	All	

800-848-6657 Toll Free  
941-927-1414 Intl'  
941-927-1612 Fax







www.baumtools.com  
sales@baumtools.com

# Volkswagen To

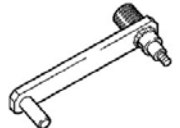
# Engine Crankshaft, Pistons

# 13

Tool Number	Application	Models	
T40011  32	<b>BELT TENSIONER LOCK PIN</b> Use to lock belt tensioner on non adjustable types. Set of 3.	VW - AHA, AKB, APH, ART, ATQ, AUG, AUX, AVK, AWD, AWM, AWN, AWP, AWV, AWW, AYS, BBD, BCY, BDP, BKF, BNU, BSB Audi - APB, AHA, ATQ, AVK, ART, AWN, BBD	<b>NEW</b> 
3211  2	<b>VIBRATION DAMPER LOCK V8</b> Hold crankshaft vibration damper when adjusting timing. Use with #3199, #3204, #V159.	Audi V8Engines: ABH, PT 1989-94	<b>NEW</b> 
T10069  4	<b>VIBRATION DAMPER HOLDING WRENCH</b> Used to counter hold vibration damper when loosening and tightening damper securing nut on W8 engine. Use with VAG1601.	VW - Golf, Jetta, GTI, Passat.Audi - A8 2005-Engines: BDF, BDP, BJS, BSB	<b>NEW</b> 
3204  3	<b>BELT TENSIONER LOCK PIN</b> See #T10060.	Audi - AAH, AFC, AAN, APB, ART, AWN, BBD VW - AEB, AHA, AKB, APB, ART, ATQ, ATW, AUG, AUX, AWM AWN, AYS, BBD, BCY	
T10060  14	<b>BELT TENSIONER LOCK PIN</b> Use to to lock tensioner of ribbed V belts in place during removal and installation. Use with #3242, #3243 and #3391. Use #3242 for later models.	Audi - AAH, AFC, AAN, APB, AHA, ATQ, AVK, ART, AWN, BBD AEG, AMB, APH, AVH, AWD, AWP, AWV, AWW, AZG, BBW, BDC, BEV, BEW, BFM, BKF, BNU	<b>NEW</b> 
3249  6	<b>BALL ALLEN SOCKET - 6mm</b> REPLACED BY #T10058.	T4 Eurovan	
T10058  6	<b>BALL ALLEN SOCKET - 6mm</b> Special long ball Allen socket for removal and installation of oil pan bolts.	VW, Audi - All	<b>NEW</b> 